

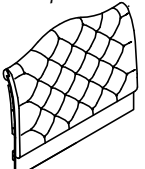







Warning :

- Be sure to check all packing material carefully for small parts, which may have come loose inside the carton during shipment.
- To prevent possible scratches and damage, this furniture **MUST BE ASSEMBLED BY TWO PEOPLE** on a soft surface such as a blanket or carpet.





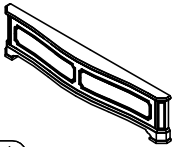
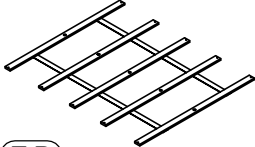
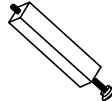

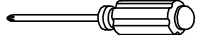
Hardware and Parts packed with the Headboard

44274 -- 5/0 Uph Headboard  (H-A) 1 pc.		Headboard Post (Left)  (H-B) 1 pc.		Headboard Post (Right)  (H-C) 1 pc.	
φ5/16"x18 x1- 3/4" Allen Head Bolt  (H-D) 10 pcs.		φ5/16" Spring Washer  (H-E) 10 pcs.		φ5/16" x 19*2mm Flat Washer  (H-F) 10 pcs.	
				5mm Allen Key  (H-G) 1 pc.	

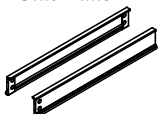
Hardware and Parts packed with the Footboard

44275 --5/0 Footboard  (F-A) 1 pc.		Wood Slat 63-1/2" long  (F-B) 1 Set.		Slat Support Leg (D) 5-3/4" x (W)1- 1/4"x (H) 1- 1/4"  (F-C) 5 pcs.		#8 x 1" Wood Screw  (F-D) 10 pcs.		Screw Driver not included 	
--	--	--	--	---	--	---	--	--	--

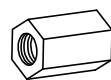
Hardware and Parts packed with the Bed Rail

44276--5/0-6/6 Side Rails  (R-A) 2 pcs.		φ5/16 x18 x3-1/2" All-Thread Bolt  (R-B) 8 pcs.		φ5/16" Curved Washer  (R-C) 8 pcs.		φ5/16" x 16*2mm Flat Washer  (R-D) 8 pcs.		φ5/16" Spring Washer  (R-E) 8 pcs.		φ5/16 x L17 Nut  (R-F) 8 pcs.		Open Wrench 12mm  (R-G) 1 pc.	
---	--	---	--	--	--	---	--	---	--	--	--	---	--

Queen Bed

44274 --5/0 Uph Headboard

44275 --5/0 Footboard

44276 --5/0-6/6 Side Rails

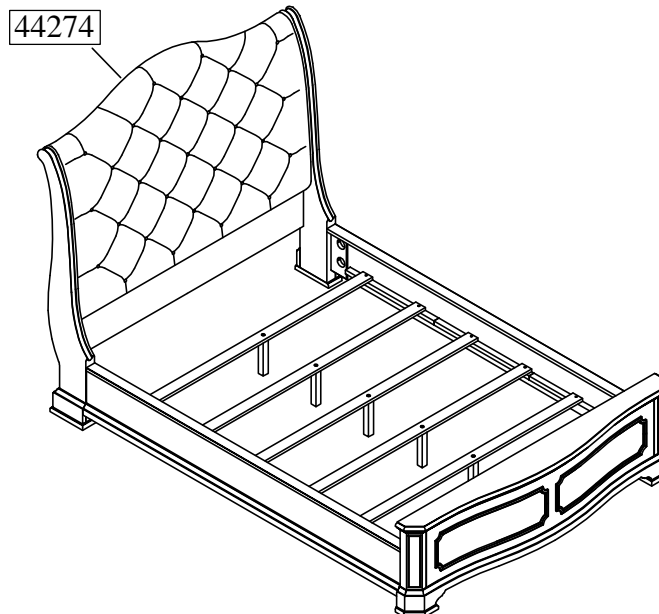

Queen Bed
44274 -- 5/0 Uph Headboard

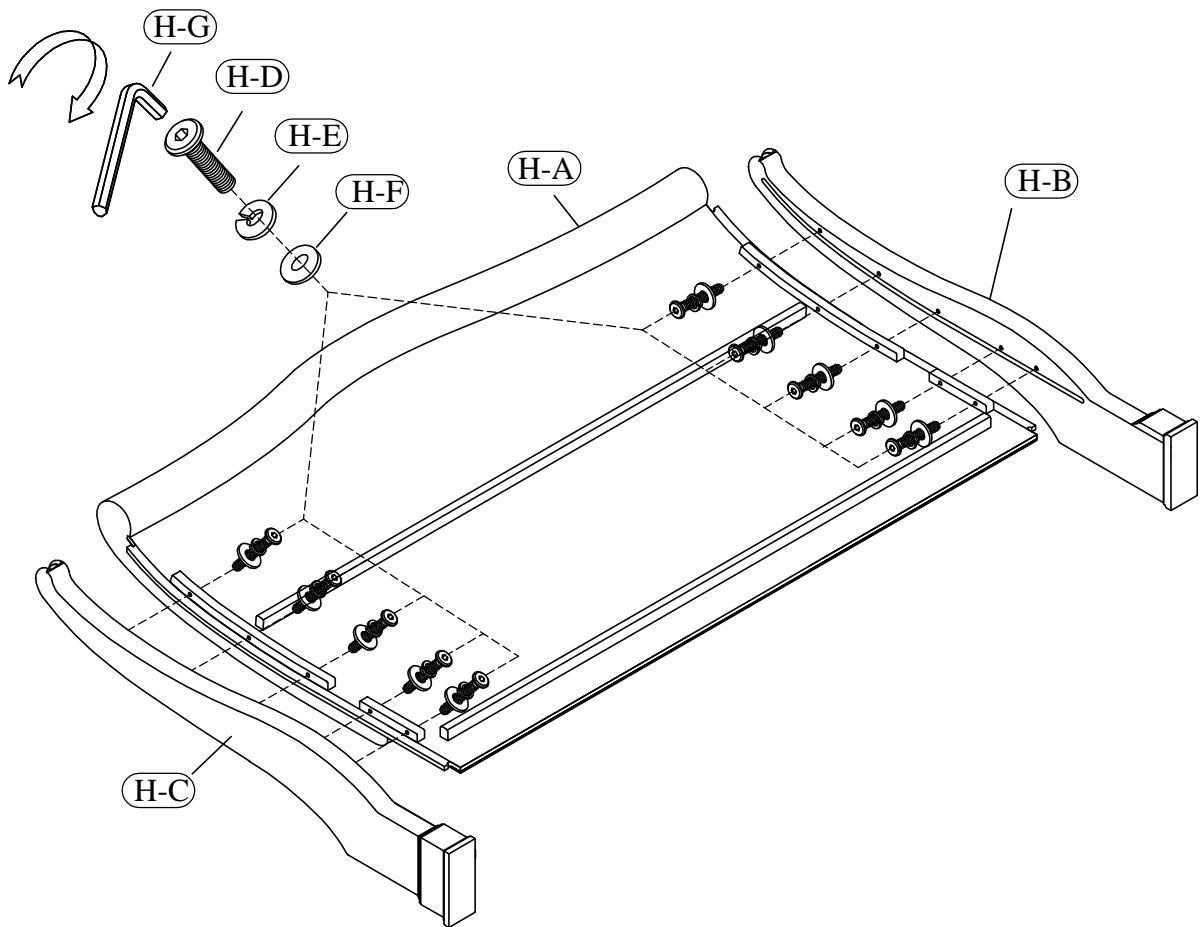

Queen Bed

44274 --5/0 Uph Headboard

44275 --5/0 Footboard

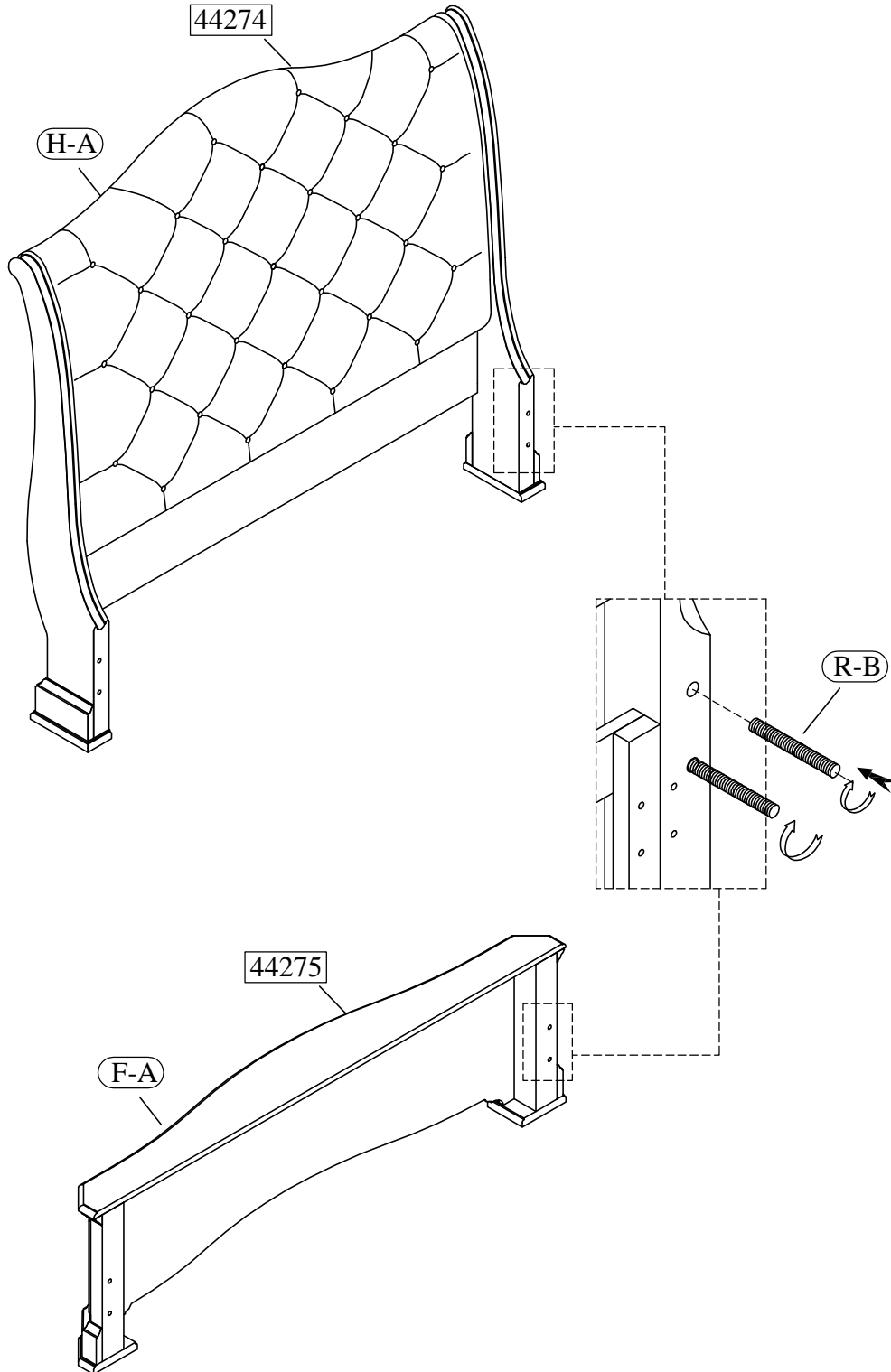

Queen Bed
44274 -- 5/0 Uph Headboard

